

1-1-2016

# The Use of Molecular Dynamics Simulations to Predict Thymine Dimer Formation in Histone Bound DNA

Emily Heinsen

*Concordia University - Portland*

Follow this and additional works at: [http://commons.cu-portland.edu/suri\\_msd](http://commons.cu-portland.edu/suri_msd)

 Part of the [Biology Commons](#)

---

## Recommended Citation

Heinsen, Emily, "The Use of Molecular Dynamics Simulations to Predict Thymine Dimer Formation in Histone Bound DNA" (2016). *Math & Science Department (SURI)*. 22.  
[http://commons.cu-portland.edu/suri\\_msd/22](http://commons.cu-portland.edu/suri_msd/22)

This Presentation is brought to you for free and open access by the Summer Undergraduate Research Institute (SURI) at CU Commons. It has been accepted for inclusion in Math & Science Department (SURI) by an authorized administrator of CU Commons. For more information, please contact [libraryadmin@cu-portland.edu](mailto:libraryadmin@cu-portland.edu).

# The Use of Molecular Dynamics Simulations to Predict Thymine Dimer Formation in Histone Bound DNA

By Emily Heinsen



# Thymine Dimers in DNA

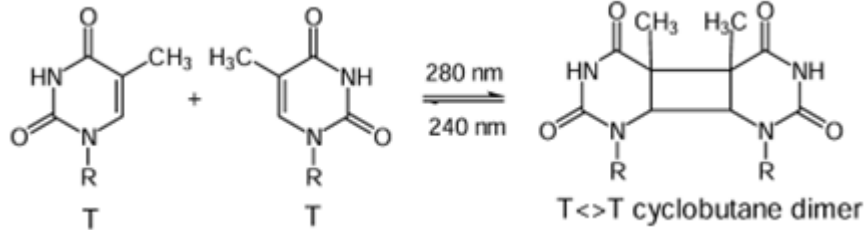

(Beukers, Eker, & Lohman, 2007)

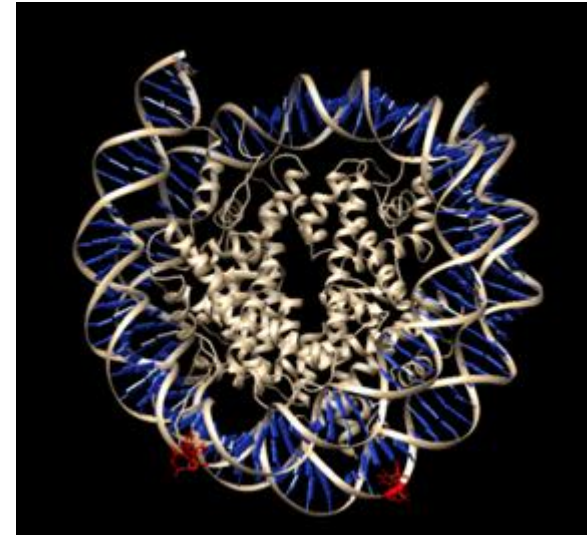

Visualization made using Chimera

# Dimers can lead to

-Interference of DNA replication

-Apoptosis

-Cancer

(Schreier, et al., 2007)

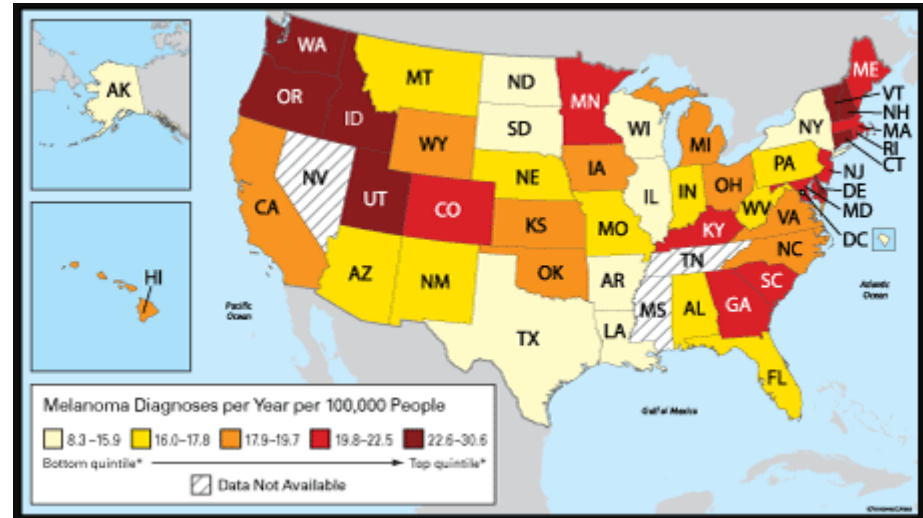

(Skin Cancer Facts For Your State)

# In order for the reaction to occur

- Distance needs to be below  $3.5\text{\AA}$  (Johnson & Wiest, 2007)
- Distance needs to be below  $4.2\text{\AA}$  (Ramamurthy & Venkatesan, 1987)
- Dihedral angle needs to be  $27^\circ \pm 3^\circ$  (Johnson & Wiest, 2007)

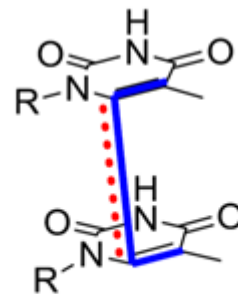

C5-C6-C6'-C5' Dihedral  
C6-C6' Distance

(Johnson, 2011)



(Pearlman, Holbrook, & Kim, 1986)

Dimers can increase the bending of the DNA molecule

-Can affect the probability of future thymine dimer formation

(Finch, Davis, & Rokita, 2013)

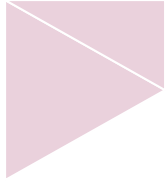

# Hypothesis

- Location of neighboring thymines around the histone can affect the probability of future thymine dimer formation
- Presence of a thymine dimer can increase the formation of subsequent thymine dimers within the DNA

# DNA around a Histone

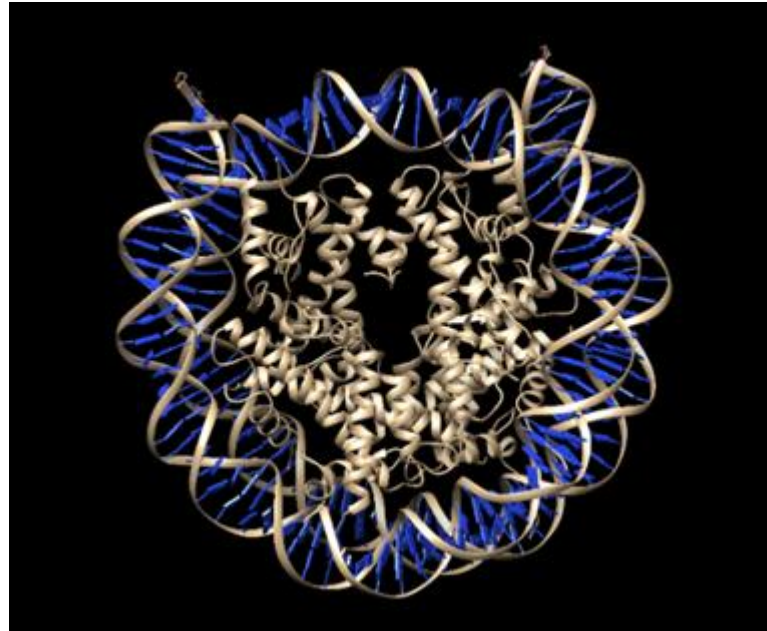

Visualization made using Chimera



# Molecular Dynamics

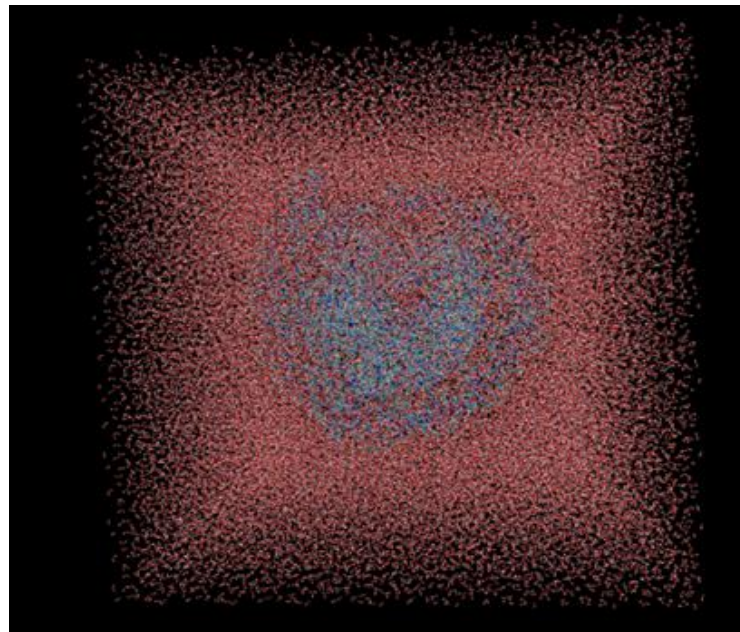
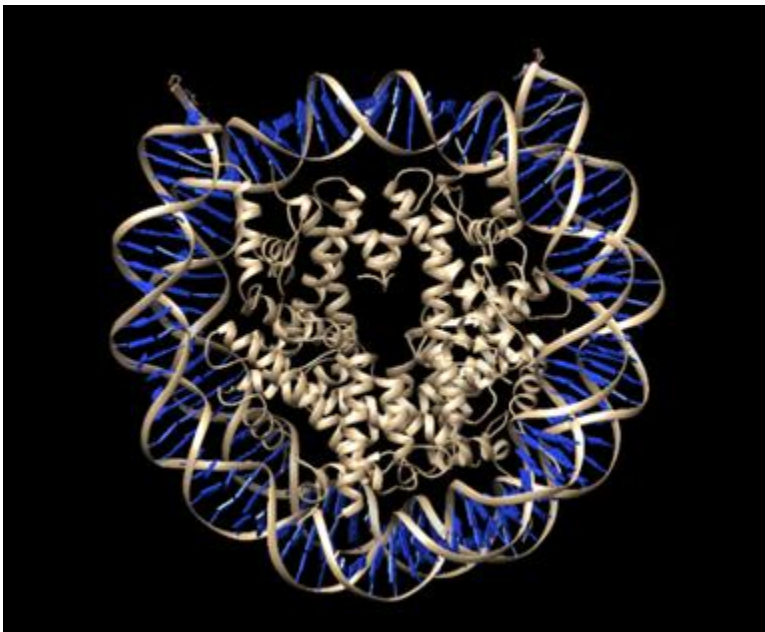

Visualizations made using Chimera

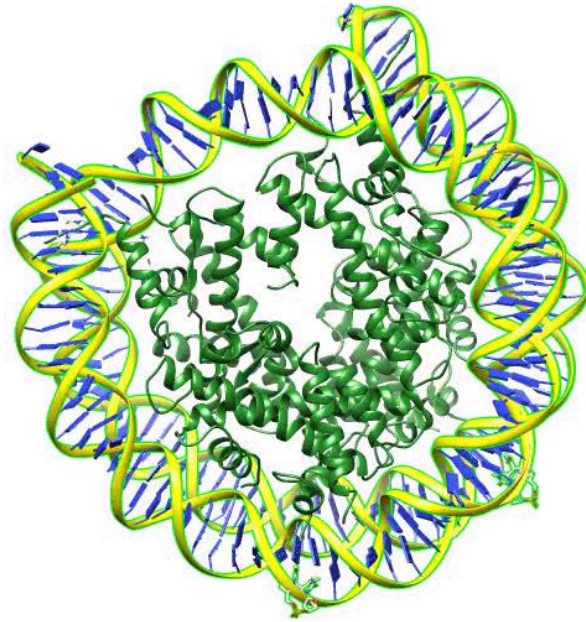

With Dimers

Movies made using VMD



# Two systems were created

System	Dimensions (Å)	Number of atoms	Number of Neighboring Thymines
NoDimer PDB ID: 5B24	149.78 x111.71 x154.02	217,910	28
Dimer PDB ID: 3AFA	153.77 x103.14 x152.78	204,189	24

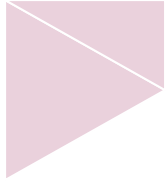

# Simulations

-Amber16, NAMD, VMD, Chimera, X3DNA

-50ns simulations were run for both systems

# Analysis

Histograms were created to see how often the neighboring thymines were in the proper orientation

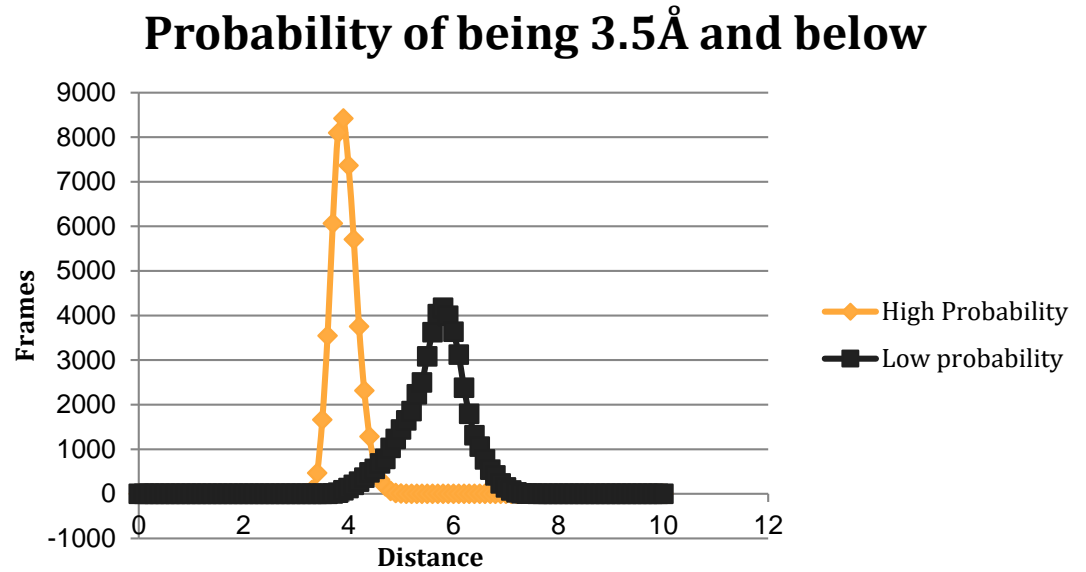

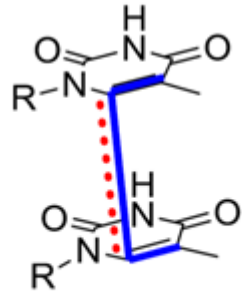

C5-C6-C6'-C5' Dihedral  
C6-C6' Distance

(Johnson, 2011)

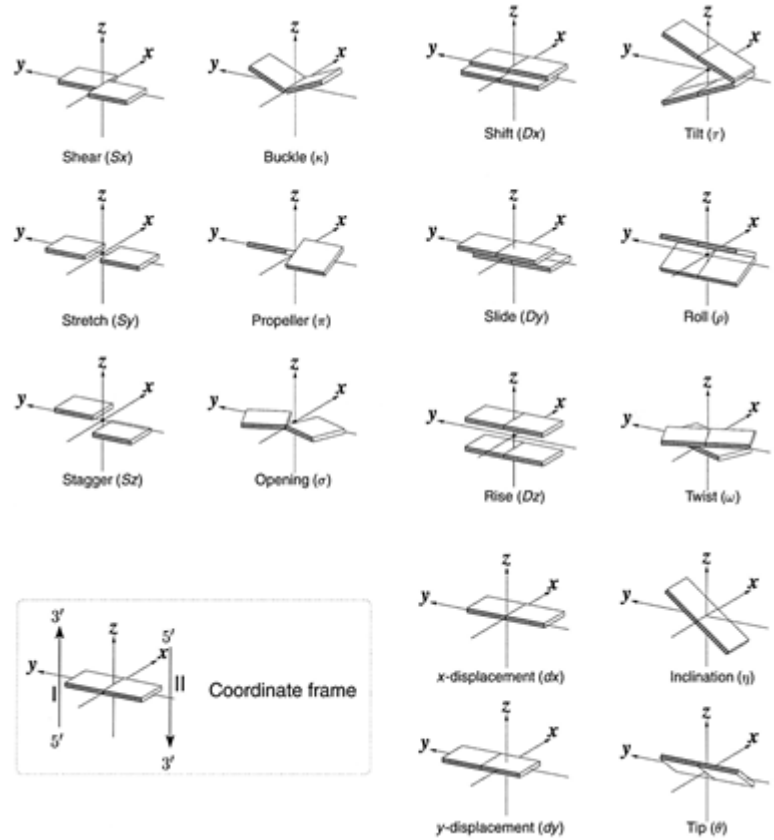

(Lu & Olsen, 2003)

## Data for both systems taken over 50ns

NoDimer	3.5 Å and Below			4.2 Å and Below			Dihedral Angle
	C5C5	C5C6	C6C6	C5C5	C5C6	C6C6	
Maximum	3.20	0.93	0.31	86.55	71.65	47.80	39.56
Minimum	0.01	0.00	0.00	7.92	6.74	3.35	2.59
Average	1.01	0.28	0.08	56.22	40.93	24.00	20.08

Dimer	3.5 Å and Below			4.2 Å and Below			Dihedral Angle
	C5C5	C5C6	C6C6	C5C5	C5C6	C6C6	
Maximum	4.45	1.18	0.31	90.36	76.32	51.01	36.95
Minimum	0.01	0.00	0.00	3.42	2.40	1.45	4.52
Average	1.24	0.32	0.09	62.38	46.00	26.60	19.56

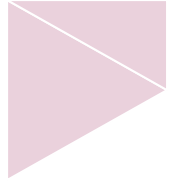

## Comparison of Percentages 3.5Å and below C5C5 bond

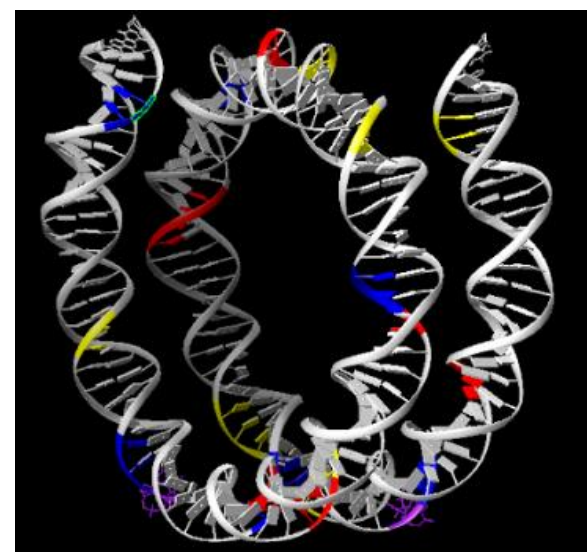
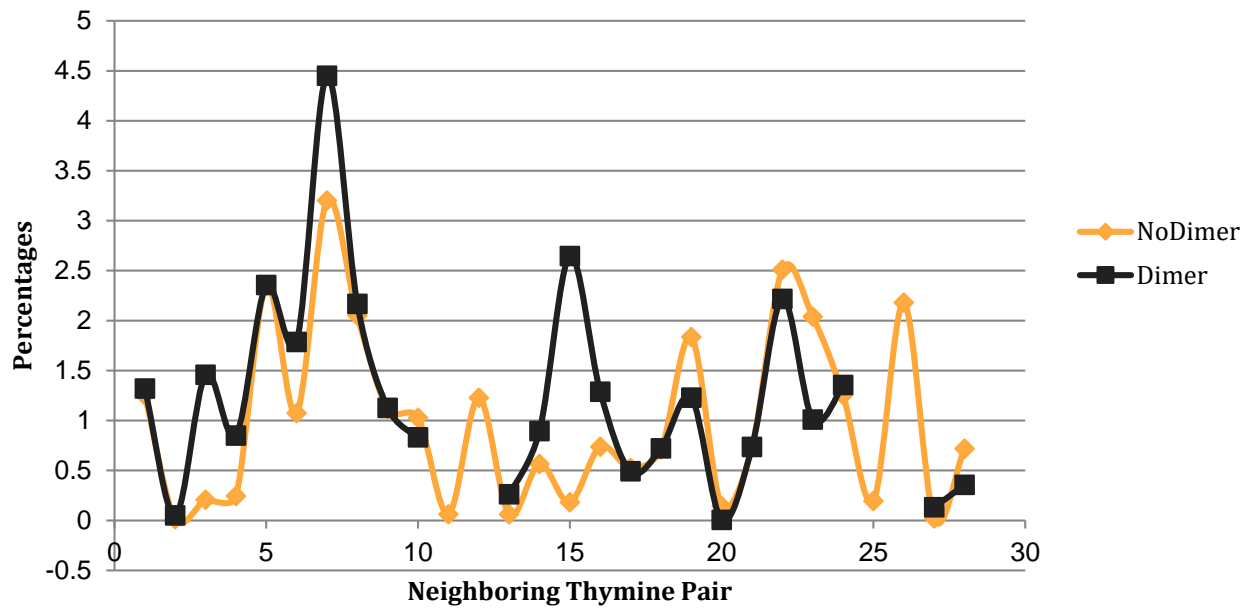





## Comparison of Percentages 3.5Å and below C6C6 bond

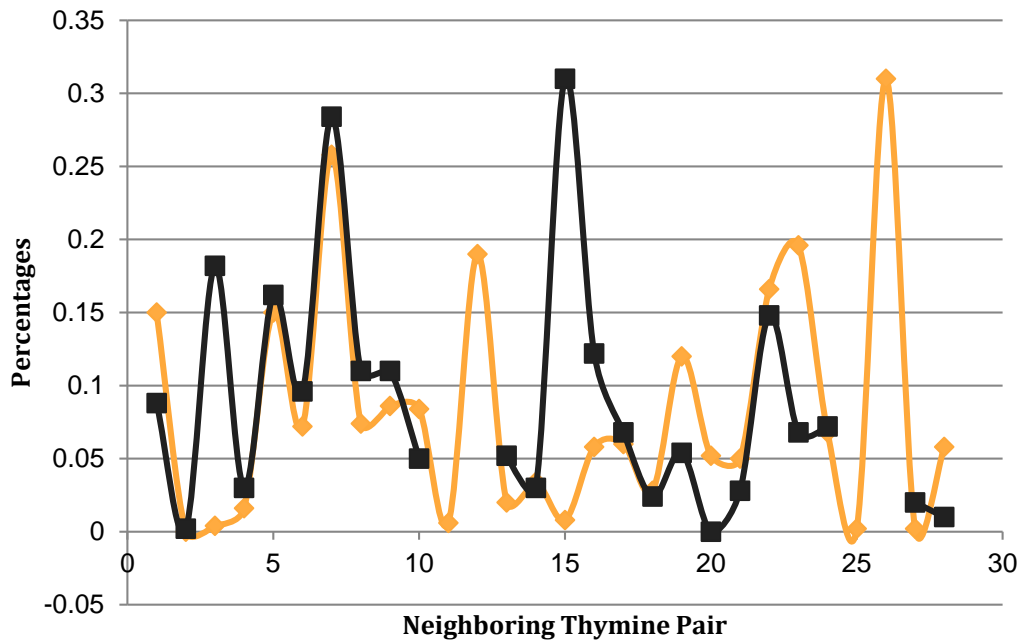

—◆— NoDimer  
—■— Dimer

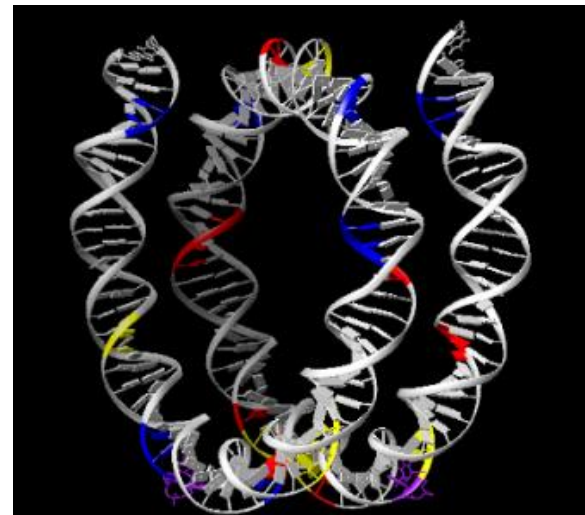
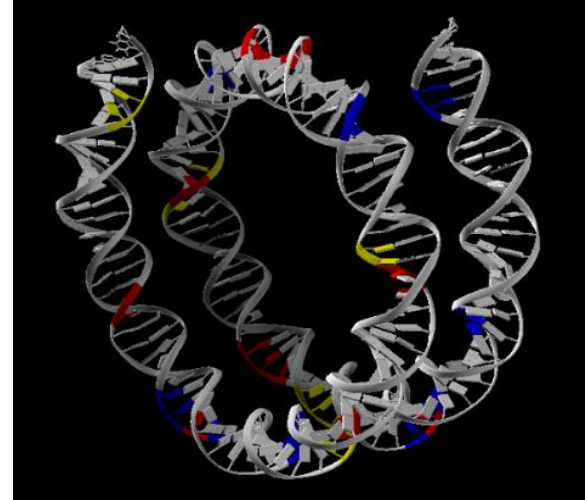

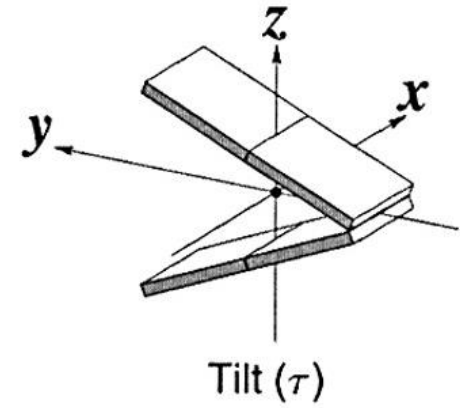
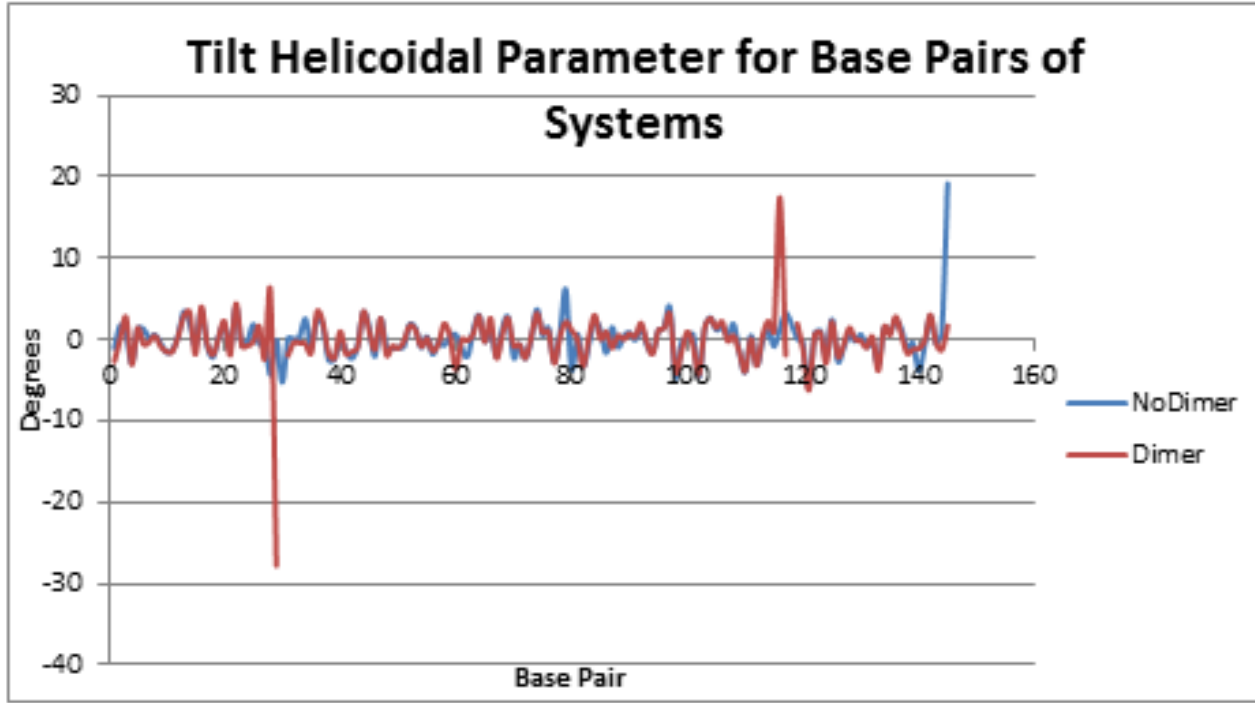

(Lu & Olsen, 2003)

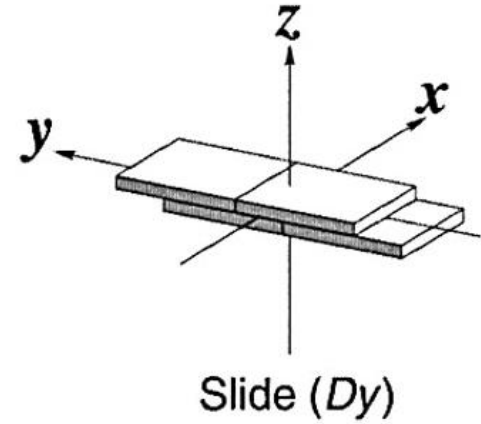
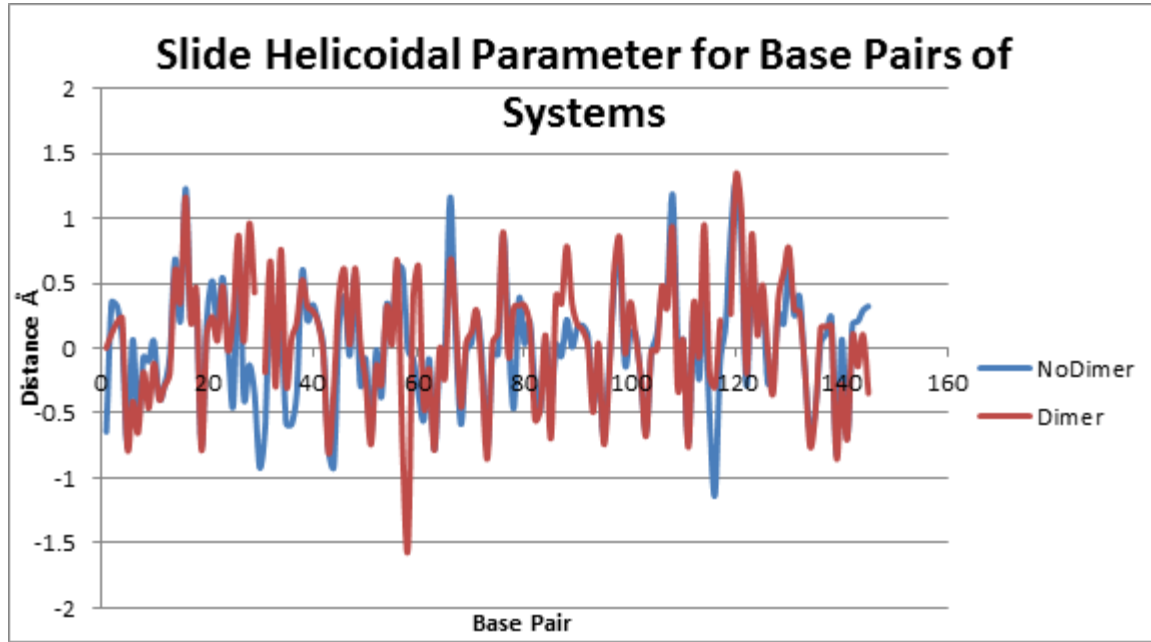
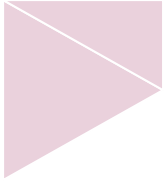

(Lu & Olsen, 2003)

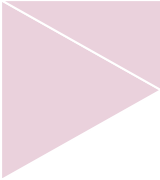

		NoDimer	Dimer
Buckle		0.415151	-0.1035
Inclination		2.852866	3.428711
Opening		-0.23803	0.630925
Propeller		-12.2353	-12.5959
Rise		3.371568	3.385457
Roll		1.239438	1.577406
Shear		-0.01142	0.002419
Shift		0.000128	-0.00281
Slide		0.009082	0.060986
Stagger		-0.02034	-0.00334
Stretch		-0.02764	-0.02578
Tilt		0.149996	-0.02948
Tip		-0.1805	0.114391
Twist		34.81735	35.00886
Xdisplacement		-0.39398	-0.35585
Ydisplacement		0.016326	-0.03016

System  
averages of  
helical  
parameters  
over 50ns

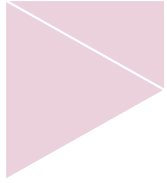

# Conclusion

-Our data suggests that the presence of a dimer within the system may lead to an increased probability of future thymine dimer formation

-Some trends for where there are areas of higher probability and of lower probability are located



# Acknowledgments

- Summer Undergraduate Research Institute (SURI) at Concordia University

-Dr. Andrew Johnson



# Citations

Beukers, R., Eker, A., & Lohman, P. (2007). 50 years thymine dimer. *Elsevier Journal*.

Finch, A., Davis, W., & Rokita, S. (2013). Accumulation of the cyclobutane thymine dimer in defined sequences of free and nucleosomal DNA. *Photochemical and Photobiological Sciences*.

Johnson, A. (2011, April). Computational Studies of Natural and Nonnatural Nucleic Acids: Formation and Repair of Thymine Dimers and Structure/Dynamics of GNA (Doctoral dissertation). Notre Dame, Indiana.

Johnson, A., & Wiest, O. (2007). Structure and Dynamics of Poly(T) Single-Strand DNA: Implications towards CPD Formation. *American Chemical Society*.

Lu, X.-J., & Olsen, W. (2003). 3DNA: a software package for the analysis, rebuilding and visualization of three-dimensional nucleic acid structures. *Oxford Journals*.

Pearlman, D., Holbrook, S., & Kim, S.-H. (1986). The Conformational Effects of UV Induced Damage on DNA. *Interrelationship Among Aging, Cancer, and Differentiation*, 163-171.

Ramamurthy, V., & Venkatesan, K. (1987). Photochemical Reactions of Organic Crystals. *Chemical Reviews*, 87.2.

Schreier, W., Schrader, T., Koller, F., Gilch, P., Crespo-Hernandez, C., Swaminathan, V., . . . Kohler, B. (2007). Thymine Dimerization in DNA is an Ultrafast Photoreaction. *Science*, 625-629. doi:10.1126/science.1135428

*Skin Cancer Facts For Your State*. (n.d.). Retrieved from United States Environmental Protection Agency:

<https://www.epa.gov/sunsafety/skin-cancer-facts-your-state-1>